

# 6-FM/NP45A

FM/NP Battery Series (General Use Battery)

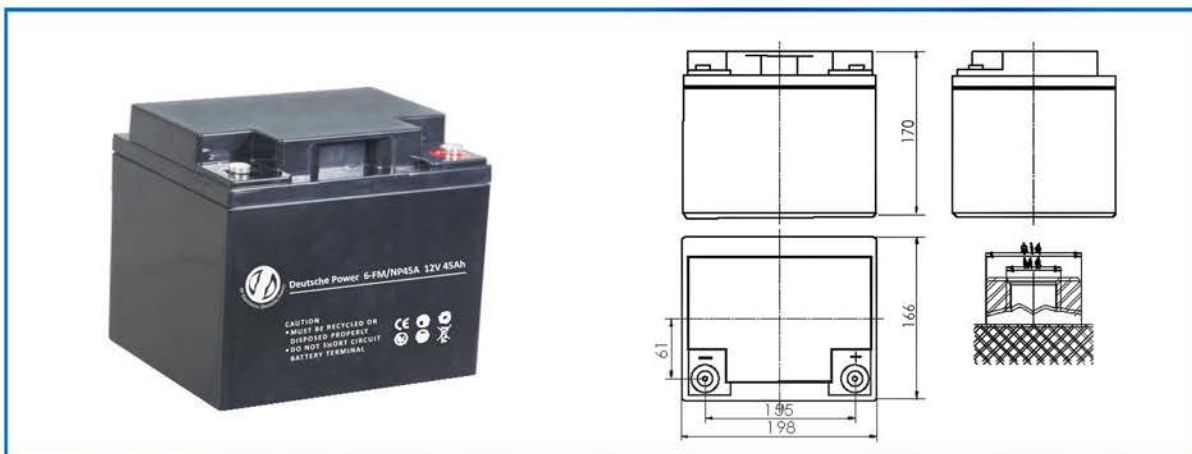

## Specifications

Nominal Voltage		12V
Rated Capacity(20 hour rate)		45Ah
Dimensions	Total Height (with terminals)	6.70inches (170mm)
	Height	6.70inches (170mm)
	Length	7.80inches (198mm)
	Width	6.54inches (166mm)
Weight		Approx. 30.36pound(13.8kg)

## Characteristics

Capacity 77°F(25°C)	20 hour rate (2.25A)	45.0Ah
	10 hour rate (4.05A)	40.5Ah
	5 hour rate (7.20A)	36.0Ah
	1 hour rate (27.0A)	27.0Ah
	15 minute Rate (74.4A)	18.6Ah
Internal Resistance	Full charged Battery 77°F(25°C)	6.5mΩ
Capacity affected by Temperature (20 hour rate)	104°F(40°C)	102%
	77°F(25°C)	100%
	32°F(0°C)	85%
	5°F(-15°C)	65%
Self-Discharge 77°F(20°C)	Capacity after 3 month storage	91%
	Capacity after 6 month storage	81%
	Capacity after 12 month storage	60%
Max. Discharge Current 77°F(25°C)	450A(5S)	
Terminal	M1	
Charge (Constant Voltage)	Cycle	Initial Charging Current less than 13.5A
		Voltage 14.4~14.7V/77°F(25°C)
	Float	Voltage 13.5~13.8V/77°F(25°C)

## Discharge Curves 77°F (25 °C)

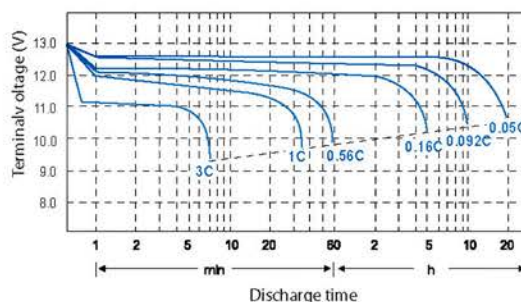

## Relationship between charge voltage and temperature

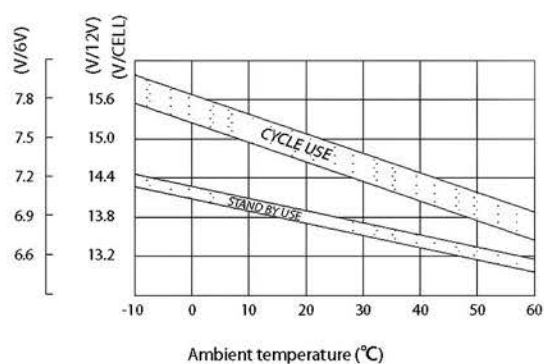

## Constant Current Discharge (AMPERES @25 °C)

F.V/Time	10Min	15Min	30Min	45Min	1Hour	2Hour	3Hour	5Hour	8Hour	10Hour	12Hour	24Hour
1.65	97.7	75.6	45.9	36.0	24.39	17.01	11.75	7.88	5.58	4.41	3.78	1.95
1.70	92.3	70.7	39.1	34.1	23.36	16.61	11.25	7.61	5.36	4.32	3.67	1.91
1.80	77.9	61.7	35.3	32.2	22.23	15.89	10.62	7.20	5.04	4.14	3.57	1.88

## Constant Power Discharge (WATTS PER CELL@25°C)

F.V/Time	10Min	15Min	30Min	45Min	1Hour	2Hour	3Hour	5Hour	8Hour	10Hour	12Hour	24Hour
1-60	169	134	83.1	62.4	52.8	29.9	21.3	14.3	9.47	8.01	6.85	3.45
1-65	164	131	82.6	61.9	51.2	29.0	21.0	14.1	9.41	7.93	6.75	3.43
1-67	162	128	81.5	60.8	50.4	28.9	20.9	14.0	9.30	7.84	6.68	3.40
1-70	160	126	80.1	59.7	49.6	28.7	20.7	13.7	9.18	7.77	6.59	3.33
1-75	151	120	79.8	58.7	49.3	28.5	20.6	13.6	9.09	7.70	6.42	3.27
1-80	138	111	75.9	56.6	48.4	27.9	20.1	13.4	8.79	7.44	6.30	3.17
1-85	115	99.0	69.1	53.8	45.0	26.9	19.6	12.7	8.54	7.11	6.06	3.08

# 6-FM/NP45A

FM/NP Battery Series (General Use Battery)

The operating environment temperature above 40°C should be avoided, after long term storage. The battery actual capacity would be less than the rated capacity. Full capacity will be obtained through several charge/discharge cycles. To get the longest life, Deutsche Power battery should be fully charged before storage.

## Cycle service life in relation to depth of discharge

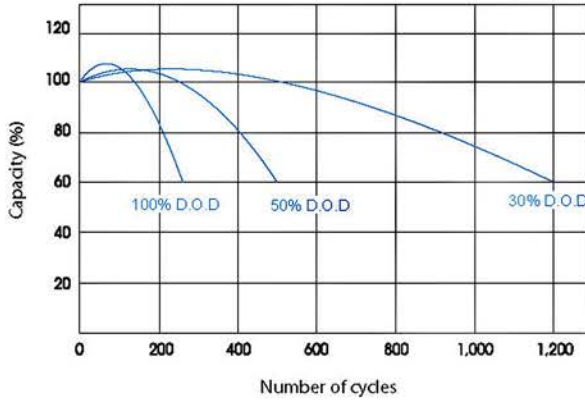

## Constant voltage charge characteristic

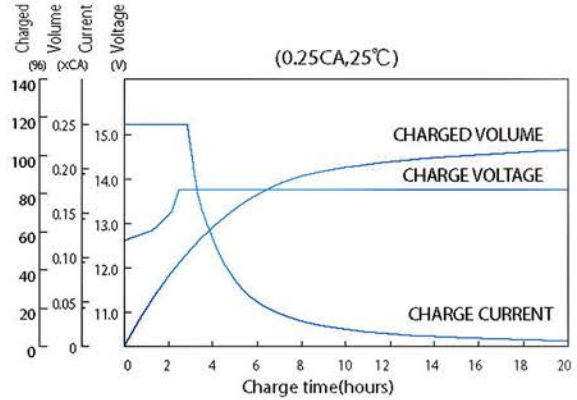

## Self-Discharge Characteristics

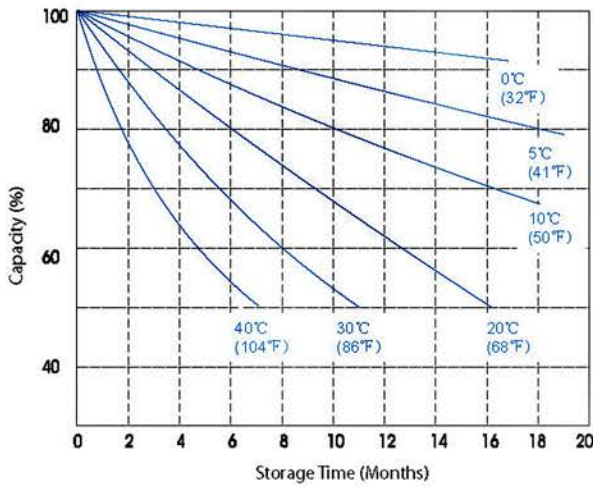

## Relationship of OCV and Residual Capacity % (25°C)

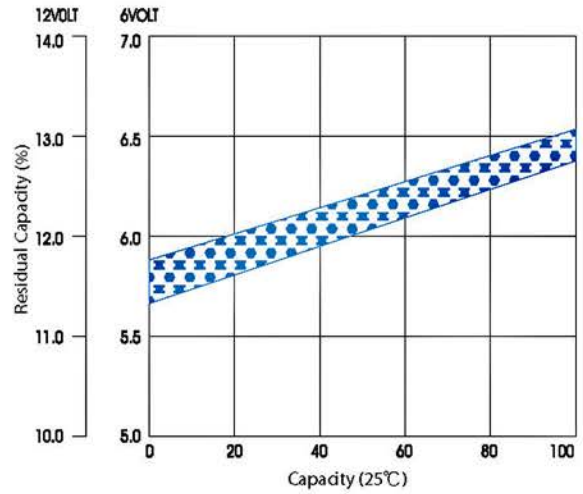

## Temperature effects on capacity

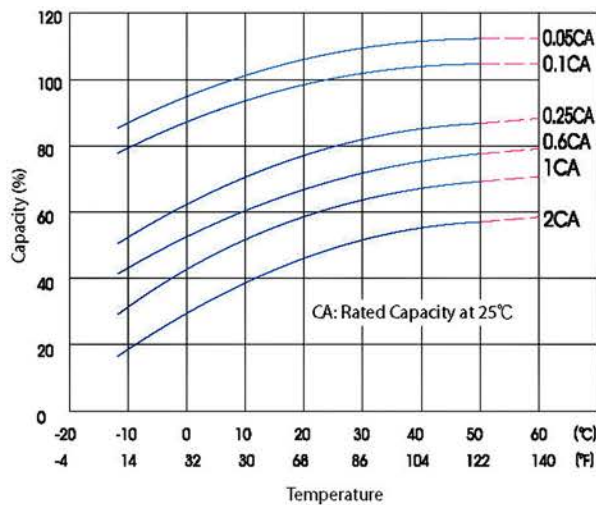

## Temperature effects float life

